

# Interfacing OLED Modules to the AT89LV52 MCU

The Parallel (8080 Series MCU)Reference Example

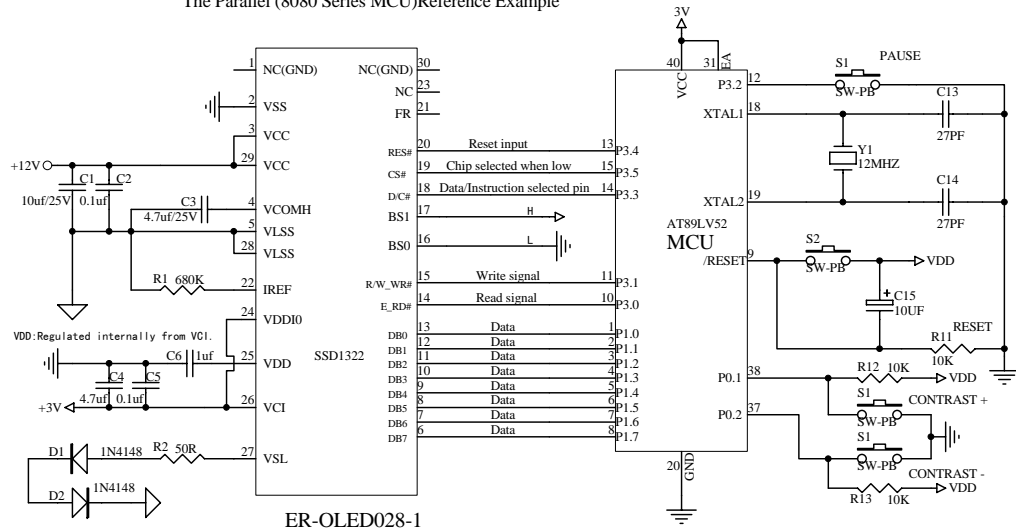

ER-OLED028-1

The Parallel (6800 Series MCU)Series MCU)Reference Example

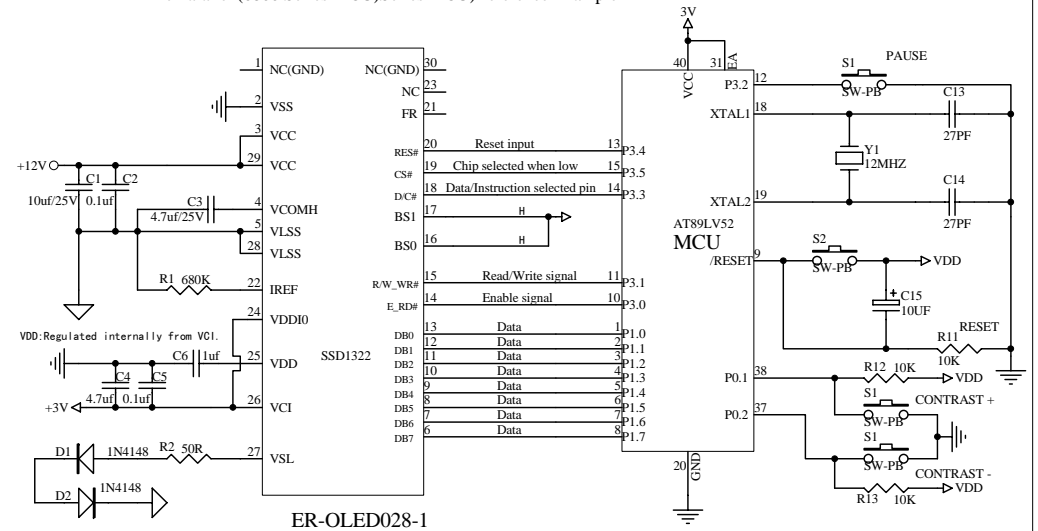

ER-OLED028-1

The Serial (4-Line SPI)Reference Example

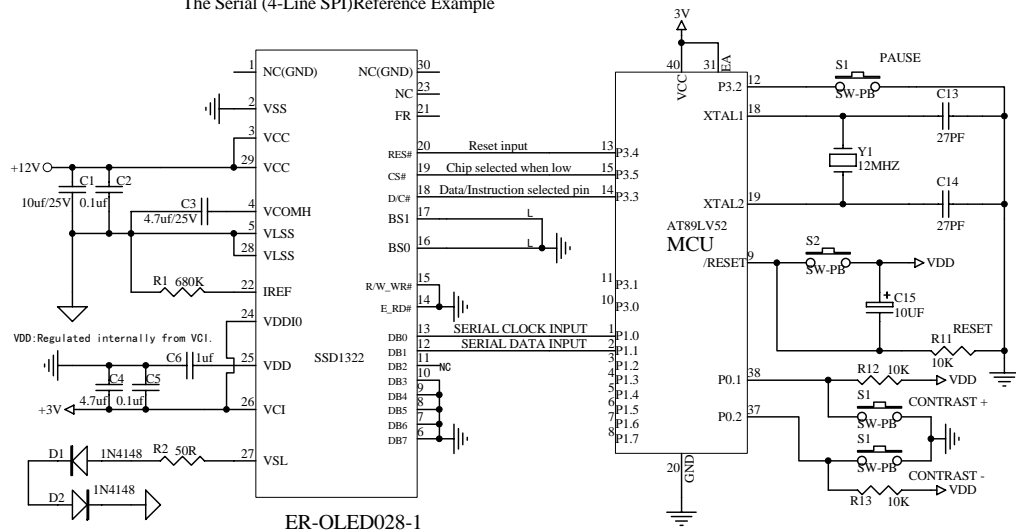

ER-OLED028-1

The Serial (3-Line SPI)Reference Example

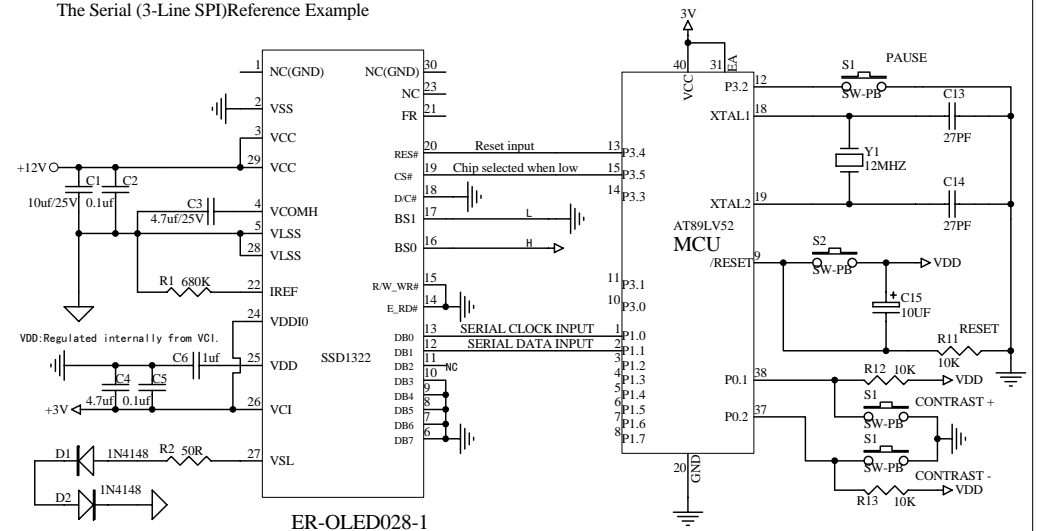

ER-OLED028-1

Title **EASTRISING TECHNOLOGY CO.,LTD.**

REV.	DESCRIPTION OF MODIFY	MODIFY BY	DATE	Size	Number	Revision
A0	1'ST DESIGN	J1M	01.05.2013	A	ER-OLED028-1 Series	A0
A1				Date:	01-May-2013	Sheet of 1
				File		Drawn By Javen