

Interfacing 5V Character LCD Module (ERM2402-1 Series) to MCU AT89C52

The Parallel 8Bit(6800 Series MCU)Reference Example

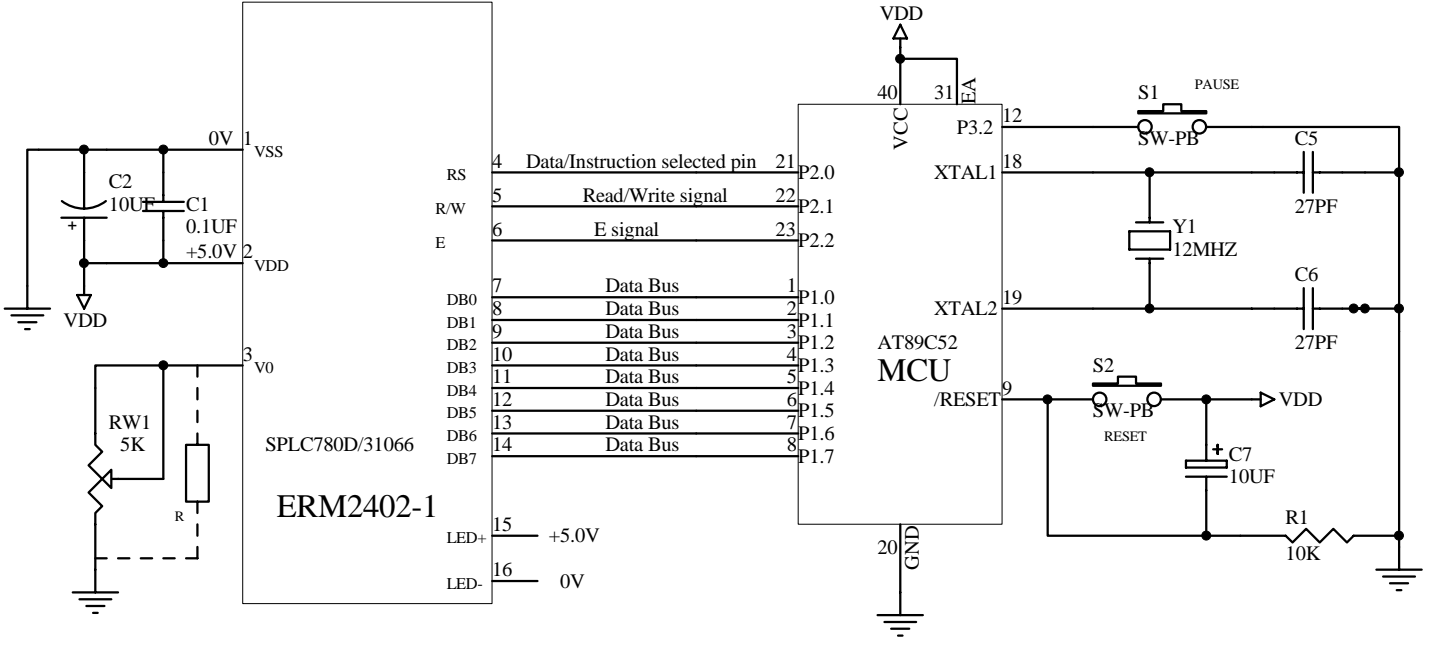

The Parallel 4Bit(6800 Series MCU)Reference Example

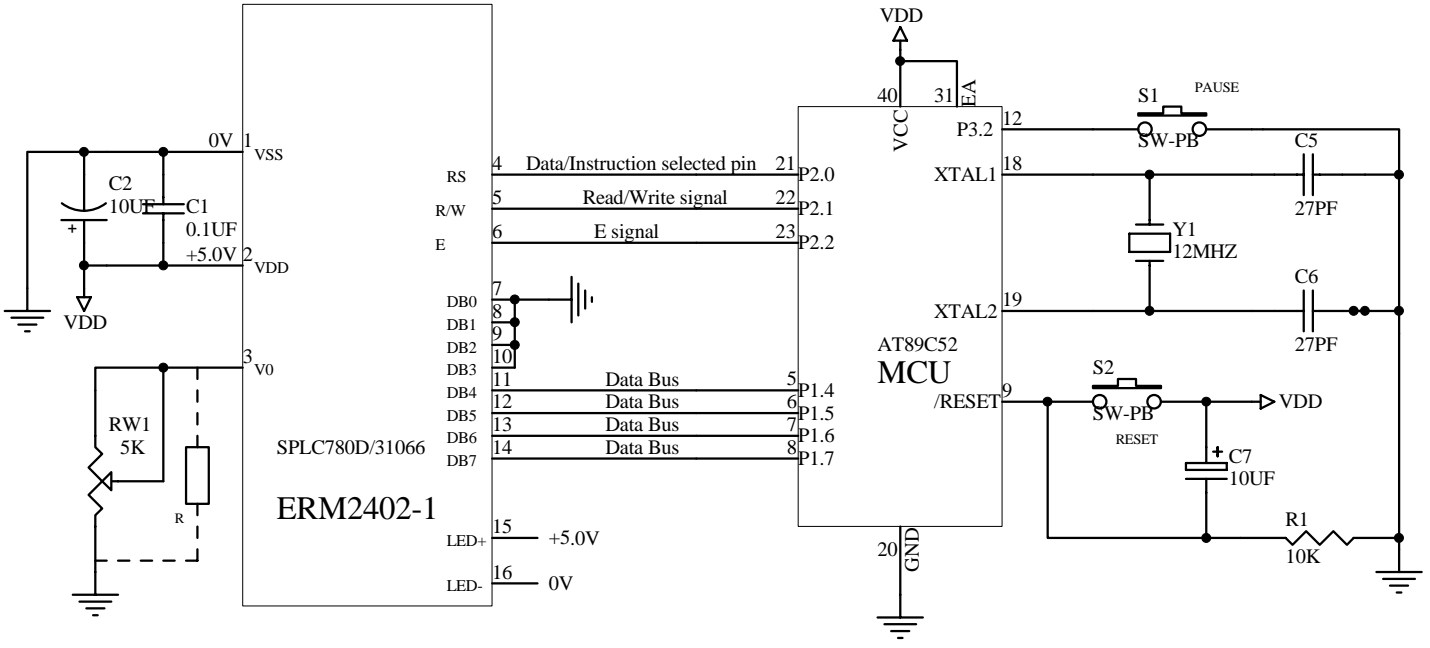

Title			EASTRISING TECHNOLOGY CO.,LTD.		
Size	Number	Revision			
A	ERM2402-1	A0			
Date:	26-Nov-2009	Sheet of	1		
File		Drawn By	Javen		

Interfacing 3.3V Character LCD Module (ERM2402-1 Series) to MCU AT89C52

The Parallel 8Bit(6800 Series MCU)Reference Example

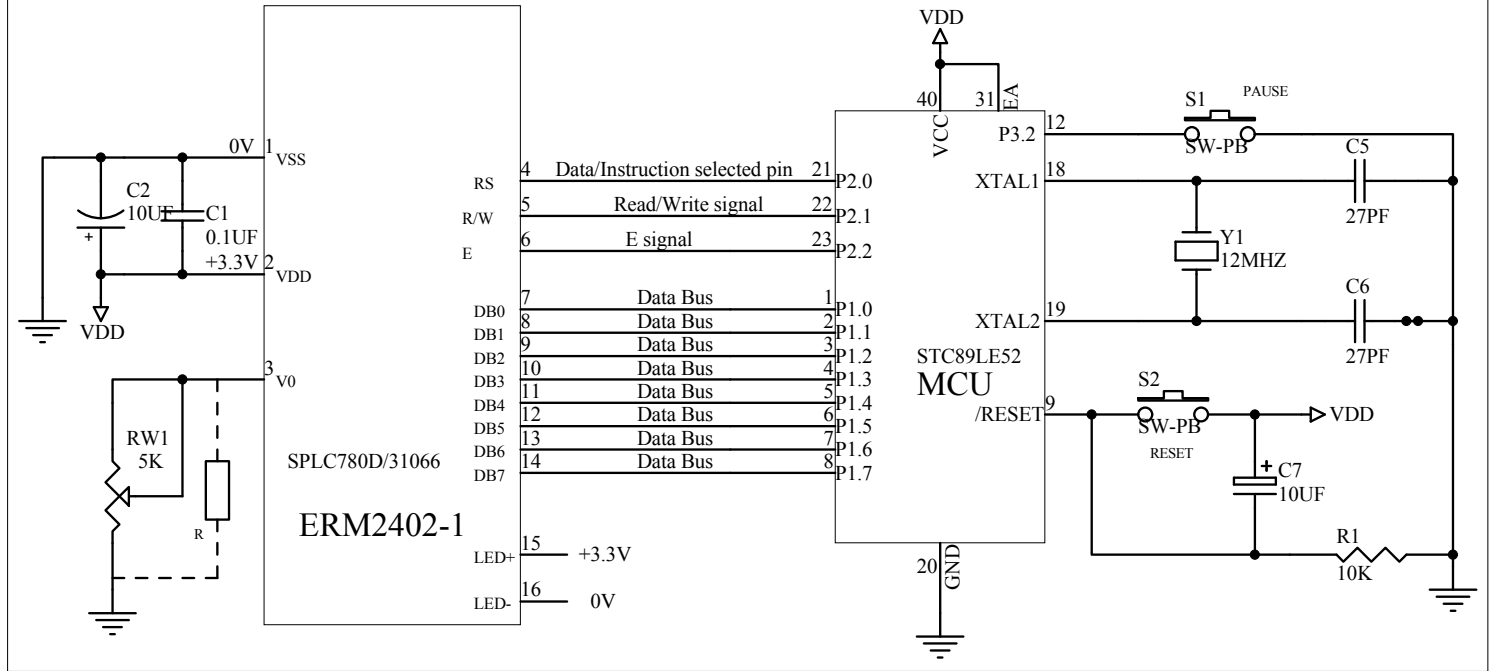

The Parallel 4Bit(6800 Series MCU)Reference Example

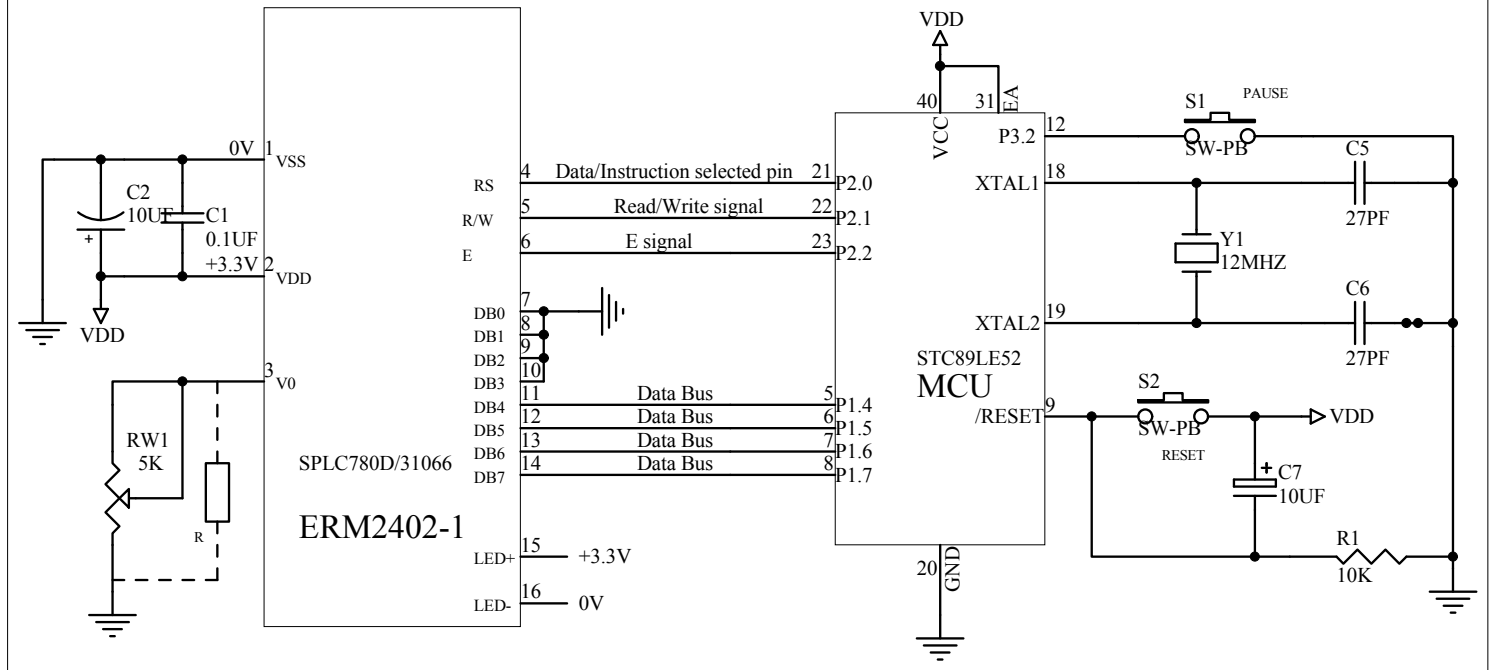

NOTE: When variable resistor RW1 is use, resistor R don't use

Title EASTRISING TECHNOLOGY CO.,LTD.			
Size	Number	ERM2402-1	Revision
A			A0
Date:	30-Mar-2016	Sheet of	1
File		Drawn By	Javen