

# ER-TFTV050-4

## TFT Display with Driver Board Datasheet



## EastRising Technology Co., Limited

**Attention:**

- A. Some specifications of IC are not listed in this datasheet. Please refer to the IC datasheet for more details.
- B. The related documents for interfacing, demo code, ic datasheet are all available, please download from our web.
- C. Please pay more attention to "INSPECTION CRITERIA" in this datasheet. We assume you already agree with these criterions when you place an order with us. No more recommendations.

REV	DESCRIPTION	RELEASE DATE
1.0	Preliminary Release	Dec-28-2013

# CONTENTS

<b>1. ORDERING INFORMATION</b> .....	04
1.1 Order Number .....	04
1.2 Accessory List .....	04
<b>2. SPECIFICATION</b> .....	05
2.1 Display Specification .....	05
2.2 Mechanical Specification .....	05
2.3 Electrical Specification .....	05
2.4 Optical Specification .....	05
<b>3. OUTLINE DRAWING</b> .....	06
3.1 TFT LCD Display Outline Drawing .....	06
3.2 Main Board / Keyboard / Remote Control Outline Drawing .....	07
3.3 Power,Keyboard,Video (CVBS),VGA Cable with Terminal Outline Drawing .....	08
<b>4. ELECTRICAL SPEC</b> .....	09
4.1.1 CN101 (TFT Display) Pin Configuration .....	09
4.1.2 J1 (Power) Pin Configuration .....	10
4.1.3 J2 (Video or CVBS) Pin Configuration .....	10
4.1.4 J3 (Keyboard) Pin Configuration .....	10
4.1.5 J4 (VGA) Pin Configuration .....	11
4.1.6 Keyboard Description .....	11
4.1.7 Remote Control Description .....	12
4.2 Absolute Maximum Ratings for TFT Display .....	12
4.3 Electrical Characteristics for TFT Display .....	12
<b>5. INSPECTION CRITERIA</b> .....	13
5.1 Acceptable Quality Level .....	13
5.2 Definition of Lot .....	13
5.3 Condition of Cosmetic Inspection .....	13
5.4 Module Cosmetic Criteria .....	14
5.5 Screen Cosmetic Criteria (Non-Operating) .....	16
5.6 Screen Cosmetic Criteria (Operating) .....	17

<b>6. PRECAUTIONS FOR USING</b> .....	19
6.1 Handling Precautions .....	19
6.2 Power Supply Precautions- .....	20
6.3 Operating Precautions .....	20
6.4 Mechanical/Environmental Precautions .....	20
6.5 Storage Precautions .....	20
6.6 Others .....	20
<b>7. USING LCD MODULES</b> .....	21
7.1 Liquid Crystal Display Modules .....	21
7.2 Installing LCD Modules .....	21
7.3 Precaution for Handling LCD Modules .....	22
7.4 Electro-Static Discharge Control- .....	22
7.5 Precaution for Soldering to EastRising LCM- .....	22
7.6 Precaution for Operation .....	23
7.7 Limited Warranty .....	23
7.8 Return Policy .....	23

## 1. ORDERING INFORMATION

### 1.1 Order Number

Part Number(Order Number)	Description
ER-TFTV050-4	5 inch TFT-LCD Display with VGA+Video(CVBS)+HDMI Board, Keyboard Cable with Terminal (J6) and 50pins to 40pins adaptor board.

### 1.2 Optional Accessory List

Accessory Name	Quantity	Position
5 inch 4-wire Resistive Touch Panel	1 piece	N/A
USB Port 4-Wire Touch Panel Driver Board	1 piece	N/A
Video (CVBS) Cable with Terminal	1 piece	J5
Power Cable with Terminal	1 piece	J3
VGA Cable with Terminal	1 piece	J4
Remote Control (Optional)	1 piece	N/A

## 2. SPECIFICATION

### 2.1 Display Specification

ITEM	STANDARD VALUE	UNIT
Display Format	800 (RGB) x 480 Dots	--
Display Connector	FPC	--
FPC Connector	40 Pin,0.5mm Pitch, SMD Horizontal Type Top contact	--
Operating Temperature	-20 ~ +70	°C
Storage Temperature	-30 ~ +80	°C
Touch Panel Optional	Yes	--
Sunlight Readable	No	--
Application	Portable Product/Industrial Device/Hand-held/Security, Instrument Display/Office Electronics	--

### 2.2 Mechanical Specification

ITEM	STANDARD VALUE	UNIT
Diagonal Size	5	inch
Outline Dimension for TFT Display	120.90(W)x75.95(H)x2.9(T)	mm
Active Area	108.0(W)x64.8(H)	mm
Pixel Size	0.135(W) x 0.135(H)	mm
Gross Weight	285	g

### 2.3 Electrical Specification

ITEM	STANDARD VALUE	UNIT
IC Package	COG	--
Driver	ILI6122	--
Interface	Video(CVBS)/VGA/HDMI	--
Response Time (Typ)	12	ms

### 2.4 Optical Specification

ITEM	STANDARD VALUE	UNIT
LCD Type	TFT-LCD / Transmissive / Positive	--
Viewing Angle Range	Left:75, Right:75, Up:75, Down:60	deg
Colors	65K/262K/16.7M	--
Contrast Ratio (Typ)	500:1	--
Brightness (Typ)	380	cd/m2

### 3. OUTLINE DRAWING

#### 3.1 TFT LCD Display Outline Drawing

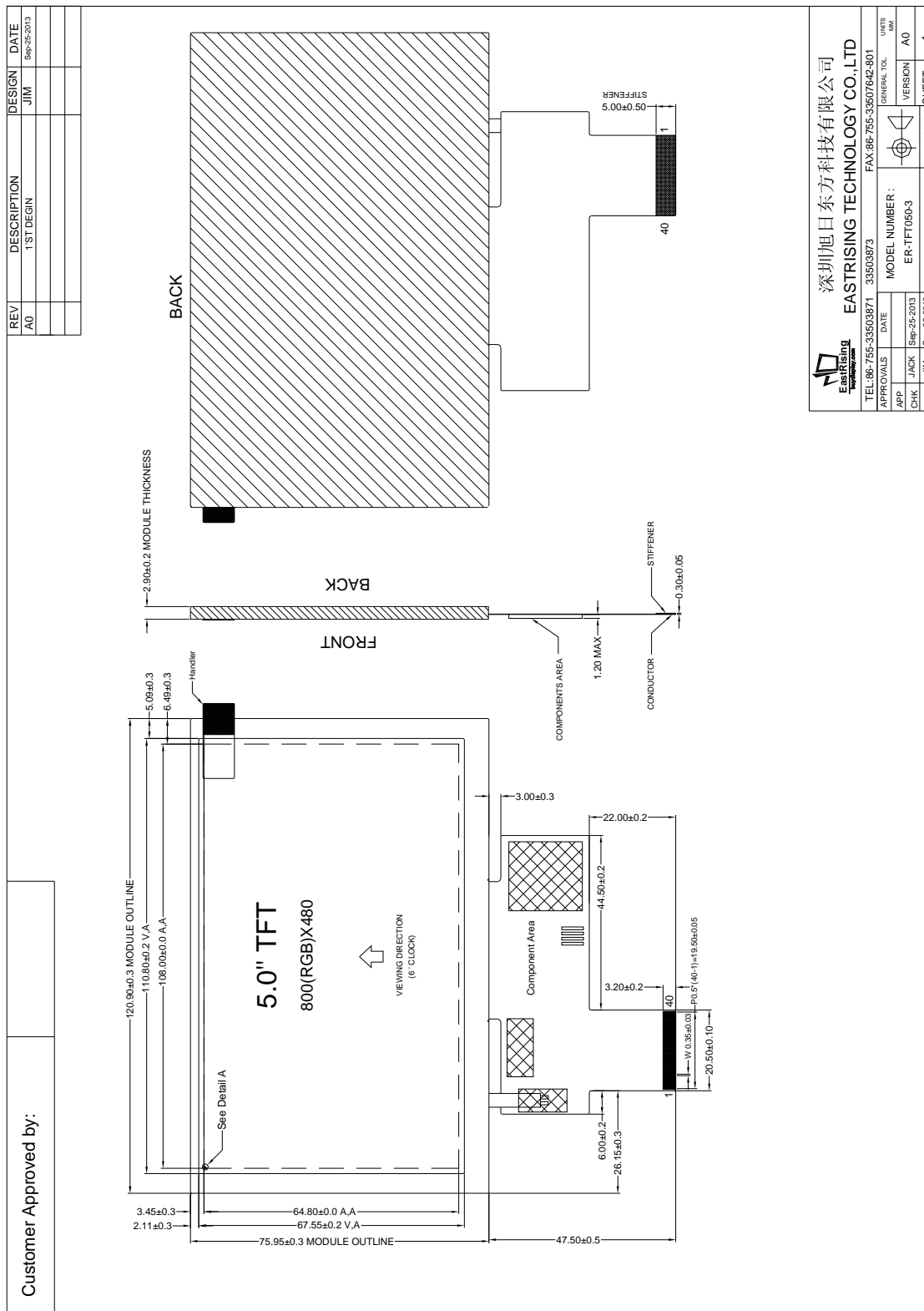

深圳旭日东方科技有限公司  
EASTRISING TECHNOLOGY CO., LTD

TEL:86-755-33503871 33503873 FAX:86-755-33507642-801  
 APP: JACK DATE: Sep-25-2013 MODEL NUMBER: ER-TFT050-3 GENERAL TOL.:  
 CHK: JIM DATE: Sep-25-2013 DO NOT SCALE THIS DRAWING. VERSION: AO UNITS: MM  
 DWN: PROJECTION: SHEET: 1

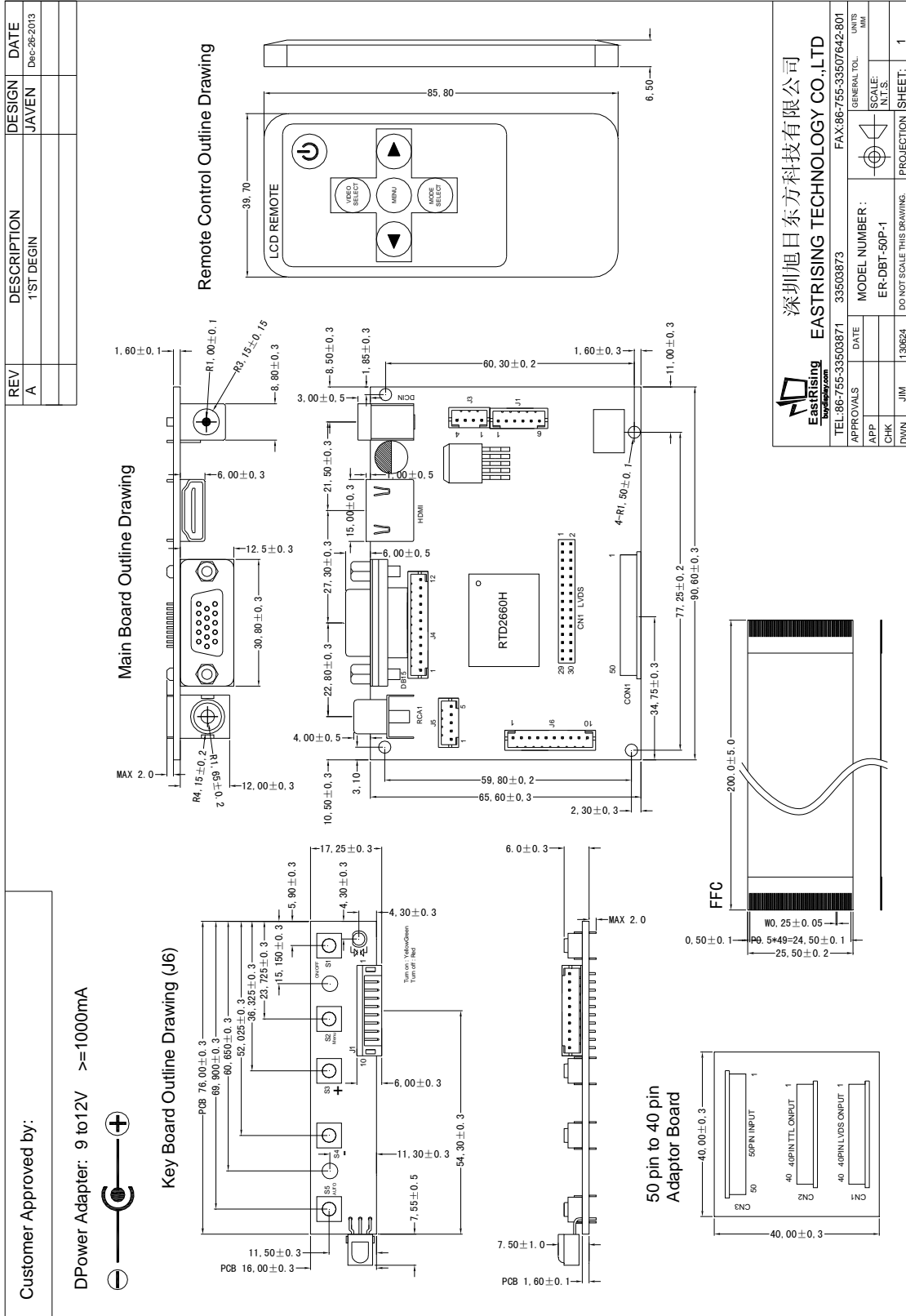

## 3.3 Power,Keyboard,Video (CVBS),VGA Cable with Terminal Outline Drawing

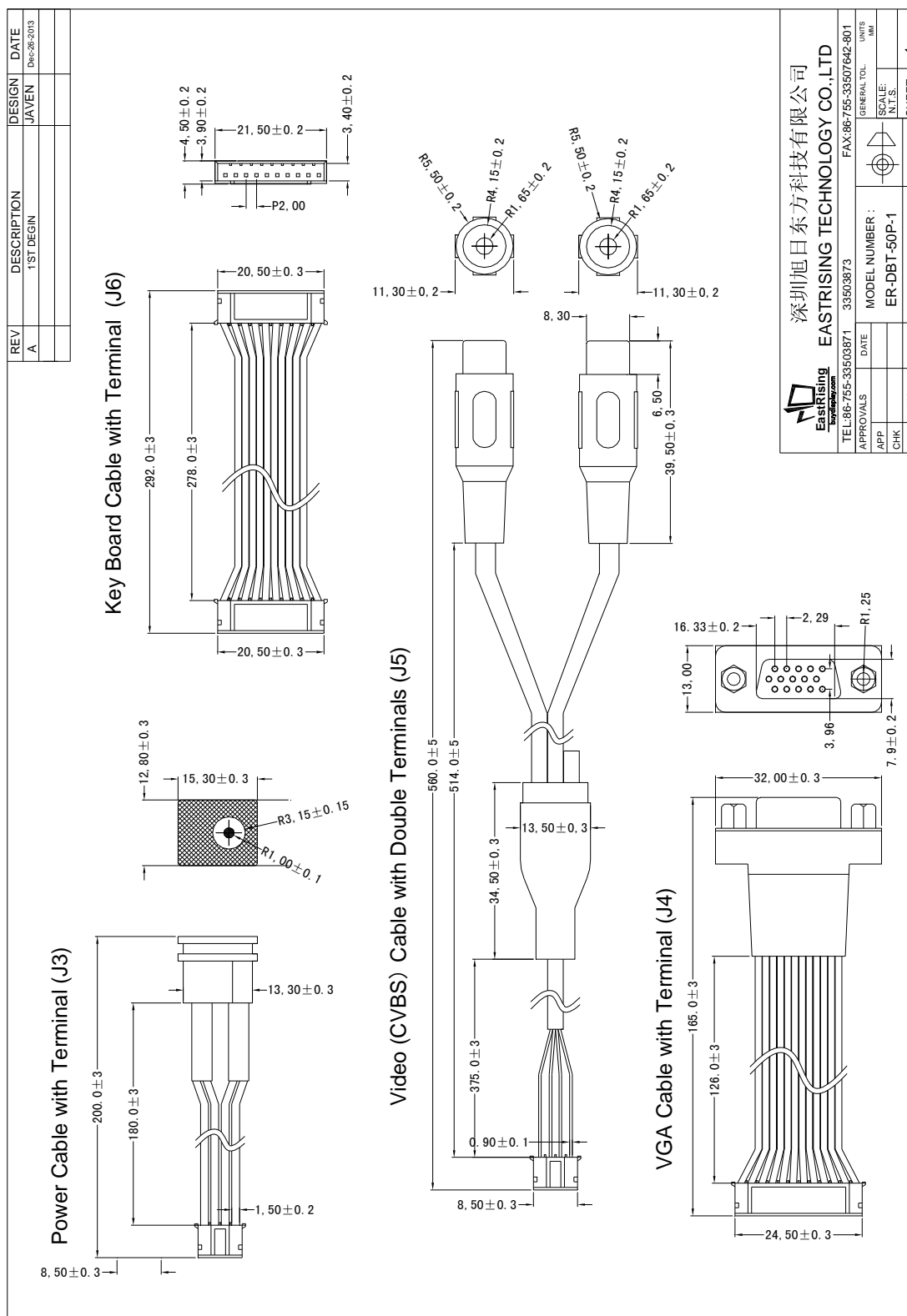



## 4. ELECTRICAL SPEC

### 4.1 Pin Configuration

#### 4.1.1 CN2 (40 pin TFT Display) Pin Configuration

Pin No	Symbol	Description
1	LEDK	LED Cathode
2	LEDA	LED Anode
3	GND	Ground
4	VDD	Power supply(Digital +3.0V)
5~12	R0~R7	Red Data
13~20	G0~G7	Green Data
21~28	B0~B7	Blue Data
29	GND	Ground
30	CLK	Clock
31	DISP	Display on/off
32	HSYNC	Horizontal sync input in RGB mode. (Short to GND if not used)
33	VSYNC	Vertical sync input in RGB mode. (Short to GND if not used)
34	DEN	Data Enable
35	NC	Not Connection
36	GND	Ground
37	XR	X_Right
38	YD	Y_Bottom
39	XL	X_Left
40	YU	Y_Up

4.1.2 J3 (Power) Pin Configuration

Pin No	Symbol	Description
1	+12V	Power Supply (Suggested power adaptor should be 12V/1000mA in output, and center pin for positive voltage and the outer shield for negative voltage)
2	+12V	Power Supply (Suggested power adaptor should be 12V/1000mA in output, and center pin for positive voltage and the outer shield for negative voltage)
3	GND	Ground
4	GND	Ground

4.1.3 J5 (Video or CVBS) Pin Configuration

Pin No	Symbol	Description
1	ACC	Voltage Input 12V for Reverse Sensor
2	Video-1 (CVBS-1)	Video (CVBS) Signal Input 1
3	GND	Ground
4	Video-2 (CVBS-2)	Video (CVBS) Signal Input 2
5	GND	Ground

4.1.4 J6 (Keyboard) Pin Configuration

Pin No	Symbol	Description
1	VCC	Keyboard Power
2	GND	Ground
3	IR	Infrared Receiver
4	K1	Power on/off (ON/OFF)
5	K2	Menu (Menu)
6	K3	Volume Increase (+)
7	K4	Volume Decrease (-)
8	K5	AV / VGA Signal Select (AUTO)
9	LED-R	LED Indicator Light in Red Color
10	LED-G	LED Indicator Light in Green Color

#### 4.1.5 J4 (VGA) Pin Configuration

Pin No	Symbol	Description
1	GND	Ground
2	V	VGA Vertical Signal Input
3	H	VGA Horizontal Signal Input
4	GND	Ground
5	R-IN	VGA Red Input
6	GND	Ground
7	G-IN	VGA Green Input
8	GND	Ground
9	B-IN	VGA Blue Input
10	GND	Ground
11	SDA	Used for Upgrade Software
12	SCL	Used for Upgrade Software

#### 4.1.6 Keyboard Description

**<AUTO>**: Press the **<AUTO>** key to switch the input signal between Video and VGA.

**<MENU>**: **Menu's definition under Video(CVAS) state**

Brightness: Adjust the photo brightness.

Contrast: Adjust the photo contrast.

Hue: Adjust the photo hue.

Saturation: Adjust the photo Saturation.

Display Ratio: Select panel display ratio in 16:9 or 4:3

Language: Select the language.

Sleep: Select the turn off times.

Reset: Restore the default settings.

Exit: Exit menu.

**Menu's definition under VGA state**

Brightness: Adjust the photo brightness.

Contrast: Adjust the photo contrast.

Hue: Adjust the photo hue.

Saturation: Adjust the photo Saturation.

Display ratio: Select panel display ratio in 16:9 or 4:3

Language: Select the language.

Sleep: Select the turn off times.

Reset: Restore the default Settings.

Auto config: Auto adjust image.

Exit: Exit Menu.

**<+>**: Press **<+>** button to move the cursor from up to down on the OSD Menu, or reduce the parameters value from small to large

**<->**: Press **<->** button to move the cursor from down to up on the OSD Menu, or reduce the parameters value from large to small.

**<ON/OFF>** : On means power on, Off means power off.

#### 4.1.7 Remote Control Description

The remote control includes five buttons, they're **Video Select (= <AUTO>)**, **Menu**, **+**, **-** and **Power (ON/OFF)**. The function is the same with Keyboard. Mode Select button is invalid.

#### 4.2 Absolute Maximum Ratings for TFT Display

ITEM	SYMBOL	MIN.	TYP.	MAX.	UNIT
Power Supply Voltage	VCI	3.0	-	+3.6	V
operating temperature	Top	-20	-	+70	° C
storage temperature	TST	-30	-	+80	° C
Humidity	RH	-		90%(Max60° C)	RH

#### 4.3 Electrical Characteristics for TFT Display

ITEM	SYMBOL	MIN.	TYP.	MAX.	UNIT
Power supply voltage	VCC	2.7	3.3	3.5	V
Input voltage'H'level	VIH	0.8*IOVCC	-	IOVCC	V
Input voltage'L'level	VIL	-0.3	-	0.2IOVCC	V
Backlight Forward Voltage	VLED	-	19.2	-	V
Backlight Current	ILED	-	40	-	mA

## 5. INSPECTION CRITERIA

### 5.1 Acceptable Quality Level

Each lot should satisfy the quality level defined as follows

<b>PARTITION</b>	<b>AQL</b>	<b>DEFINITION</b>
A. Major	0.4%	Functional defective as product
B. Minor	1.5%	Satisfy all functions as product but not satisfy cosmetic standard

### 5.2 Definition of Lot

One lot means the delivery quantity to customer at one time.

### 5.3 Condition of Cosmetic Inspection

#### ◆ INSPECTION AND TEST

- FUNCTION TEST
- APPEARANCE INSPECTION
- PACKING SPECIFICATION

#### ◆ INSPECTION CONDITION

- Put under the lamp (20W) at a distance 100mm from
- Tilt upright 45 degree by the front (back) to inspect LCD appearance.

#### ◆ AQL INSPECTION LEVEL

- SAMPLING METHOD: MIL-STD-105D
- SAMPLING PLAN: SINGLE
- MAJOR DEFECT: 0.4% (MAJOR)
- MINOR DEFECT: 1.5% (MINOR)
- GENERAL LEVEL: II/NORMAL

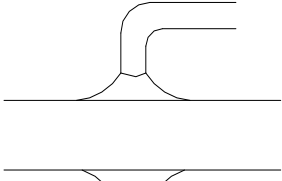
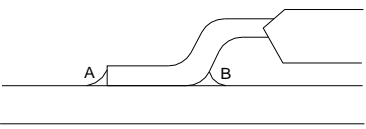
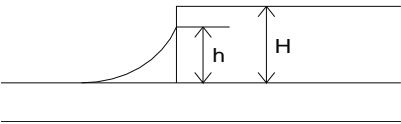
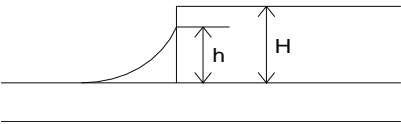
NO.	Item	Judgment Criterion	Partition
1	Difference in Spec.	None allowed	Major
2	Pattern Peeling	No substrate pattern peeling and floating	Major
3	Soldering defects	No soldering missing	Major
		No soldering bridge	Major
		No cold soldering	Minor
4	Resist flaw on substrate	Invisible copper foil( $\varnothing$ 0.5mm or more)on substrate pattern	Minor
5	Accretion of metallic Foreign matter	No soldering dust	Minor
		No accretion of metallic foreign matters(Not exceed $\varnothing$ 0.2mm)	
6	Stain	No stain to spoil cosmetic badly	Minor
7	Plate discoloring	No plate fading,rusting and discoloring	Minor
8	Solder amount	<p>a. Soldering side of PCB</p> <p>Solder to form a 'Filet' all around the lead. Solder should not hide the lead form perfectly.(too much)</p>  <p>b.Components side (In case of 'Through Hole PCB')</p> <p>Solder to reach the Components side of PCB</p> 	Minor
	2.Flat packages	<p>Either 'toe'(A) or 'heel' (B) of the lead to be covered by 'Filet'</p>  <p>Lead form to be assume over Solder.</p>	Minor
	3.Chips	<p><math>(3/2) H \cong h \cong (1/2)H</math></p> 	Minor

9	Backlight defects	<ol style="list-style-type: none"> <li>1. Light fails or flickers. (Major)</li> <li>2. Color and luminance do not correspond to specifications. (Major)</li> <li>3. Exceeds standards for display's blemishes, foreign matter, dark lines or scratches. (Minor)</li> </ol>	<p>See list ←</p>
10	PCB defects	<p>Oxidation or contamination on connectors.*</p> <ol style="list-style-type: none"> <li>2. Wrong parts, missing parts, or parts not in specification.*</li> <li>3. Jumpers set incorrectly. (Minor)</li> <li>4. Solder (if any) on bezel, LED pad, zebra pad, or screw hole pad is not smooth. (Minor)</li> </ol> <p>*Minor if display functions correctly. Major if the display fails.</p>	<p>See list ←</p>
11	Soldering defects	<ol style="list-style-type: none"> <li>1. Unmelted solder paste.</li> <li>2. Cold solder joints, missing solder connections, or oxidation.*</li> <li>3. Solder bridges causing short circuits.*</li> <li>4. Residue or solder balls.</li> <li>5. Solder flux is black or brown.</li> </ol> <p>*Minor if display functions correctly. Major if the display fails.</p>	<p>Minor</p>

5.5 Screen Cosmetic Criteria (Non-Operating)

No.	Defect	Judgment Criterion	Partition	
1	Spots	In accordance with Screen Cosmetic Criteria (Operating) No.1.	Minor	
2	Lines	In accordance with Screen Cosmetic Criteria (Operation) No.2.	Minor	
3	Bubbles in Polarizer		Minor	
		Size: d mm		Acceptable Qty in active area
		d ≤ 0.3		Disregard
		0.3 < d ≤ 1.0		3
1.0 < d ≤ 1.5	1			
1.5 < d	0			
4	Scratch	In accordance with spots and lines operating cosmetic criteria, When the light reflects on the panel surface, the scratches are not to be remarkable.	Minor	
5	Allowable density	Above defects should be separated more than 30mm each other.	Minor	
6	Coloration	Not to be noticeable coloration in the viewing area of the LCD panels. Back-lit type should be judged with back-lit on state only.	Minor	
7	Contamination	Not to be noticeable.	Minor	

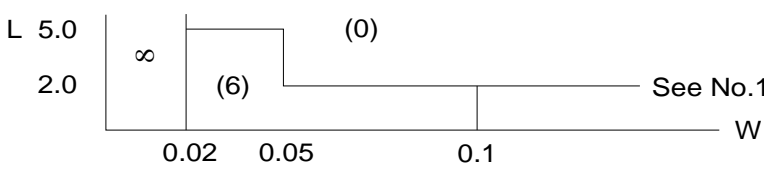
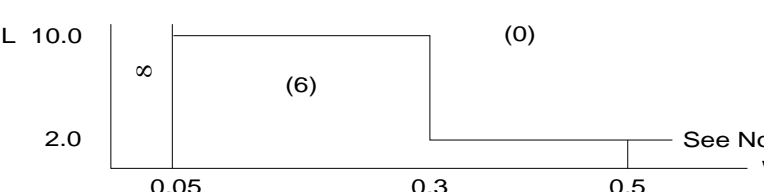

No.	Defect	Judgment Criterion	Partition																				
1	Spots	<p>A) Clear</p> <table border="1" data-bbox="416 376 1361 600"> <thead> <tr> <th>Size:d mm</th> <th>Acceptable Qty in active area</th> </tr> </thead> <tbody> <tr> <td><math>d \leq 0.1</math></td> <td>Disregard</td> </tr> <tr> <td><math>0.1 &lt; d \leq 0.2</math></td> <td>6</td> </tr> <tr> <td><math>0.2 &lt; d \leq 0.3</math></td> <td>2</td> </tr> <tr> <td><math>0.3 &lt; d</math></td> <td>0</td> </tr> </tbody> </table> <p>Note: Including pin holes and defective dots which must be within one pixel Size.</p> <p>B) Unclear</p> <table border="1" data-bbox="416 734 1361 947"> <thead> <tr> <th>Size:d mm</th> <th>Acceptable Qty in active area</th> </tr> </thead> <tbody> <tr> <td><math>d \leq 0.2</math></td> <td>Disregard</td> </tr> <tr> <td><math>0.2 &lt; d \leq 0.5</math></td> <td>6</td> </tr> <tr> <td><math>0.5 &lt; d \leq 0.7</math></td> <td>2</td> </tr> <tr> <td><math>0.7 &lt; d</math></td> <td>0</td> </tr> </tbody> </table>	Size:d mm	Acceptable Qty in active area	$d \leq 0.1$	Disregard	$0.1 < d \leq 0.2$	6	$0.2 < d \leq 0.3$	2	$0.3 < d$	0	Size:d mm	Acceptable Qty in active area	$d \leq 0.2$	Disregard	$0.2 < d \leq 0.5$	6	$0.5 < d \leq 0.7$	2	$0.7 < d$	0	Minor
Size:d mm	Acceptable Qty in active area																						
$d \leq 0.1$	Disregard																						
$0.1 < d \leq 0.2$	6																						
$0.2 < d \leq 0.3$	2																						
$0.3 < d$	0																						
Size:d mm	Acceptable Qty in active area																						
$d \leq 0.2$	Disregard																						
$0.2 < d \leq 0.5$	6																						
$0.5 < d \leq 0.7$	2																						
$0.7 < d$	0																						
2	Lines	<p>A) Clear</p>  <p>Note: () – Acceptable Qty in active area  L - Length (mm)  W -Width(mm)  ∞-Disregard</p> <p>B) Unclear</p> 	Minor																				
<p>'Clear' = The shade and size are not changed by Vo.  'Unclear' = The shade and size are changed by Vo.</p>																							

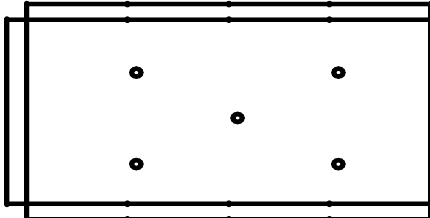
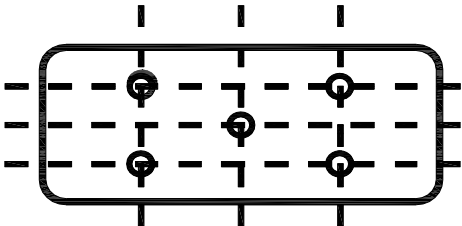
No.	Defect	Judgment Criterion	Partition
3	Rubbing line	Not to be noticeable.	
4	Allowable density	Above defects should be separated more than 10mm each other.	Minor
5	Rainbow	Not to be noticeable.	Minor
6	Dot size	To be 95%~105%of the dot size (Typ.) in drawing. Partial defects of each dot (ex.pin-hole) should be treated as'spot'. (see Screen Cosmetic Criteria (Operating) No.1)	Minor
7	Brightness (only back-lit Module)	Brightness Uniformity must be $B_{MAX}/B_{MIN} \leq 2$ - $B_{MAX}$ :Max.value by measure in 5 points - $B_{MIN}$ : Min.value by measure in 5 points Divide active area into 4 vertically and horizontally. Measure 5 points shown in the following figure. 	Minor
8	Contrast Uniformity	Contrast Uniformity must be $B_{mAX}/B_{mIN} \leq 2$ Measure 5 points shown in the following figure. Dashed lines divide active area into 4 vertically and horizontally. Measuring points are located at the inter-sections of dashed line.  Note: $B_{MAX}$ – Max.value by measure in 5 points. $B_{MIN}$ – Min.value by measure in 5 points. O – Measuring points in $\varnothing 10\text{mm}$ .	Minor

Note:

- (1) Size :  $d=(\text{long length} + \text{short length})/2$
- (2) The limit samples for each item have priority.
- (3) Complexed defects are defined item by item, but if the number of defects is defined in above table, the total number should not exceed 10.
- (4) In case of 'concentration', even the spots or the lines of 'disregarded' size should not be allowed. Following three situations  
Should be treated as 'concentration'.
  - 7 or over defects in circle of  $\varnothing 5\text{mm}$ .
  - 10 or over defects in circle of  $\varnothing 10\text{mm}$

-20 or over defects in circle of  $\varnothing$  20mm

## 6. PRECAUTIONS FOR USING

### 6.1 Handling Precautions

- ◆ This device is susceptible to Electro-Static Discharge (ESD) damage. Observe Anti-Static precautions.
- ◆ EastRising display panel is made of glass. Do not subject it to a mechanical shock by dropping it or impact.
- ◆ If EastRising display panel is damaged and the liquid crystal substance leaks out, be sure not to get any in your mouth. If the substance contacts your skin or clothes, wash it off using soap and water.
- ◆ Do not apply excessive force to the EastRising display surface or the adjoining areas since this may cause the color tone to vary.
- ◆ The polarizer covering the EastRising display surface of the LCD module is soft and easily scratched. Handle this polarizer carefully.
- ◆ If EastRising display surface becomes contaminated, breathe on the surface and gently wipe it with a soft dry cloth. If it is heavily contaminated, moisten cloth with one of the following Isopropyl or alcohol.
- ◆ Solvents other than those above-mentioned may damage the polarizer. Especially, do not use the Water.
- ◆ Exercise care to minimize corrosion of the electrode. Corrosion of the electrodes is accelerated by water droplets, moisture condensation or a current flow in a high-humidity environment.
- ◆ Install the EastRising LCD Module by using the mounting holes. When mounting the LCD module make sure it is free of twisting, warping and distortion. In particular, do not forcibly pull or bend the cable or the backlight cable.
- ◆ Do not attempt to disassemble or process EastRising LCD module.
- ◆ NC terminal should be open. Do not connect anything.
- ◆ If the logic circuit power is off, do not apply the input signals.
- ◆ To prevent destruction of the elements by static electricity, be careful to maintain an optimum work environment.
  - Be sure to ground the body when handling EastRising LCD modules.
  - Tools required for assembling, such as soldering irons, must be properly grounded.
  - To reduce the amount of static electricity generated, do not conduct assembling and other work under dry conditions.
  - The LCD module is coated with a film to protect the display surface. Exercise care when peeling off this protective film since static electricity may be generated.

### 6.2 Power Supply Precautions

- ◆ Identify and, at all times, observe absolute maximum ratings for both logic and LC drivers. Note that there is some variance between models.
- ◆ Prevent the application of reverse polarity to VDD and VSS, however briefly.
- ◆ Use a clean power source free from transients. Power-up conditions are occasionally jolting and may exceed the maximum ratings of EastRising modules.
- ◆ The VDD power of EastRising module should also supply the power to all devices that may access the display. Don't allow the data bus to be driven when the logic supply to the module is turned off.

### 6.3 Operating Precautions

- ◆ DO NOT plug or unplug EastRising module when the system is powered up.
- ◆ Minimize the cable length between EastRising module and host MPU.
- ◆ For models with backlights, do not disable the backlight by interrupting the HV line. Unload inverters produce voltage extremes that may arc within a cable or at the display.
- ◆ Operate EastRising module within the limits of the modules temperature specifications.

### 6.4 Mechanical/Environmental Precautions

- ◆ Improper soldering is the major cause of module difficulty. Use of flux cleaner is not recommended as they may seep under the electrometric connection and cause display failure.
- ◆ Mount EastRising module so that it is free from torque and mechanical stress.
- ◆ Surface of the LCD panel should not be touched or scratched. The display front surface is an easily scratched, plastic polarizer. Avoid contact and clean only when necessary with soft, absorbent cotton dampened with petroleum benzene.
- ◆ Always employ anti-static procedure while handling EastRising module.
- ◆ Prevent moisture build-up upon the module and observe the environmental constraints for storage tem
- ◆ Do not store in direct sunlight
- ◆ If leakage of the liquid crystal material should occur, avoid contact with this material, particularly ingestion. If the body or clothing becomes contaminated by the liquid crystal material, wash thoroughly with water and soap

### 6.5 Storage Precautions

When storing the LCD modules, avoid exposure to direct sunlight or to the light of fluorescent lamps. Keep EastRising modules in bags (avoid high temperature / high humidity and low temperatures below 0C Whenever possible, EastRising LCD modules should be stored in the same conditions in which they were shipped from our company.

### 6.6 Others

Liquid crystals solidify under low temperature (below the storage temperature range) leading to defective orientation or the generation of air bubbles (black or white). Air bubbles may also be generated if the module is subject to a low temperature.

If EastRising LCD modules have been operating for a long time showing the same display patterns, the

display patterns may remain on the screen as ghost images and a slight contrast irregularity may also appear. A normal operating status can be regained by suspending use for some time. It should be noted that this phenomenon does not adversely affect performance reliability.

To minimize the performance degradation of the LCD modules resulting from destruction caused by static electricity etc., exercise care to avoid holding the following sections when handling the modules.

- Exposed area of the printed circuit board.
- Terminal electrode sections.

## **7. USING LCD MODULES**

### **7.1 Liquid Crystal Display Modules**

EastRising LCD is composed of glass and polarizer. Pay attention to the following items when handling.

- ◆ Please keep the temperature within specified range for use and storage. Polarization degradation, bubble generation or polarizer peel-off may occur with high temperature and high humidity.
- ◆ Do not touch, push or rub the exposed polarizers with anything harder than an HB pencil lead (glass, tweezers, etc.).
- ◆ N-hexane is recommended for cleaning the adhesives used to attach front/rear polarizers and reflectors made of organic substances which will be damaged by chemicals such as acetone, toluene, ethanol and isopropylalcohol.
- ◆ When EastRising display surface becomes dusty, wipe gently with absorbent cotton or other soft material like chamois soaked in petroleum benzin. Do not scrub hard to avoid damaging the display surface.
- ◆ Wipe off saliva or water drops immediately, contact with water over a long period of time may cause deformation or color fading.
- ◆ Avoid contacting oil and fats.
- ◆ Condensation on the surface and contact with terminals due to cold will damage, stain or dirty the polarizers. After products are tested at low temperature they must be warmed up in a container before coming in contact with room temperature air.
- ◆ Do not put or attach anything on EastRising display area to avoid leaving marks on.
- ◆ Do not touch the display with bare hands. This will stain the display area and degradate insulation between terminals (some cosmetics are determined to the polarizers).
- ◆ As glass is fragile. It tends to become or chipped during handling especially on the edges. Please avoid dropping or jarring.

### **7.2 Installing LCD Modules**

- ◆ Cover the surface with a transparent protective plate to protect the polarizer and LC cell.
- ◆ When assembling the LCM into other equipment, the spacer to the bit between the LCM and the fitting plate should have enough height to avoid causing stress to the module surface, refer to the individual specifications for measurements. The measurement tolerance should be  $\pm 0.1\text{mm}$ .

### 7.3 Precaution for Handling LCD Modules

Since EastRising LCM has been assembled and adjusted with a high degree of precision; avoid applying excessive shocks to the module or making any alterations or modifications to it.

- ◆ Do not alter, modify or change the shape of the tab on the metal frame.
- ◆ Do not make extra holes on the printed circuit board, modify its shape or change the positions of components to be attached.
- ◆ Do not damage or modify the pattern writing on the printed circuit board.
- ◆ Absolutely do not modify the zebra rubber strip (conductive rubber) or heat seal connector.
- ◆ Except for soldering the interface, do not make any alterations or modifications with a soldering iron.
- ◆ Do not drop, bend or twist EastRising LCM.

### 7.4 Electro-Static Discharge Control

Since this module uses a CMOS LSI, the same careful attention should be paid to electrostatic discharge as for an ordinary CMOS IC.

- ◆ Make certain that you are grounded when handling LCM.
- ◆ Before remove LCM from its packing case or incorporating it into a set, be sure the module and your body have the same electric potential.
- ◆ When soldering the terminal of LCM, make certain the AC power source for the soldering iron does not leak.
- ◆ When using an electric screwdriver to attach LCM, the screwdriver should be of ground potentiality to minimize as much as possible any transmission of electromagnetic waves produced sparks coming from the commutator of the motor.
- ◆ As far as possible make the electric potential of your work clothes and that of the work bench the ground potential.
- ◆ To reduce the generation of static electricity be careful that the air in the work is not too dried. A relative humidity of 50%-60% is recommended.

### 7.5 Precaution for Soldering to EastRising LCM

- ◆ Observe the following when soldering lead wire, connector cable and etc. to the LCM.

-Soldering iron temperature :  $280^{\circ}\text{C} \pm 10^{\circ}\text{C}$

-Soldering time: 3-4 sec.

-Solder: eutectic solder.

If soldering flux is used, be sure to remove any remaining flux after finishing to soldering operation. (This does not apply in the case of a non-halogen type of flux.) It is recommended that you protect the LCD surface with a cover during soldering to prevent any damage due to flux spatters.

- ◆ When soldering the electroluminescent panel and PC board, the panel and board should not be detached more than three times. This maximum number is determined by the temperature and time conditions mentioned above, though there may be some variance depending on the temperature of the soldering iron.
- ◆ When remove the electroluminescent panel from the PC board, be sure the solder has completely melted, the soldered pad on the PC board could be damaged.

#### 7.6 Precaution for Operation

- ◆ Viewing angle varies with the change of liquid crystal driving voltage (VO). Adjust VO to show the best contrast.
- ◆ Driving the EastRising LCD in the voltage above the limit shortens its life.
- ◆ Response time is greatly delayed at temperature below the operating temperature range. However, this does not mean the LCD will be out of the order. It will recover when it returns to the specified temperature range.
- ◆ If EastRising display area is pushed hard during operation, the display will become abnormal. However, it will return to normal if it is turned off and then back on.
- ◆ Condensation on terminals can cause an electrochemical reaction disrupting the terminal circuit. Therefore, it must be used under the relative condition of 40°C, 50% RH.
- ◆ When turning the power on, input each signal after the positive/negative voltage becomes stable.

#### 7.7 Limited Warranty

Unless agreed between EastRising and customer, EastRising will replace or repair any of its LCD modules which are found to be functionally defective when inspected in accordance with EastRising LCD acceptance standards (copies available upon request) for a period of one year from date of shipments. Cosmetic/visual defects must be returned to EastRising within 90 days of shipment. Confirmation of such date shall be based on freight documents. The warranty liability of EastRising limited to repair and/or replacement on the terms set forth above. EastRising will not be responsible for any subsequent or consequential events.

#### 7.8 Return Policy

No warranty can be granted if the precautions stated above have been disregarded. The typical examples of violations are:

- Broken LCD glass.
- PCB eyelet damaged or modified.
- PCB conductors damaged.
- Circuit modified in any way, including addition of components.
- PCB tampered with by grinding, engraving or painting varnish.
- Soldering to or modifying the bezel in any manner.

Module repairs will be invoiced to the customer upon mutual agreement. Modules must be returned with sufficient description of the failures or defects. Any connectors or cable installed by the customer must be removed completely without damaging the PCB eyelet's, conductors and terminals

**That's the end of the datasheet**